



環氧樹脂地面漆是專業為各種工業廠房及貨倉，提供地板淨化、防腐、防靜電、耐腐、耐壓產品，除生產外本公司更提供施工、設計及保養的一體化專業服務。廣泛用於大型貨倉、物流中心、生化、醫藥、紡織、印染、食品、電子、化工、塑膠、五金、電鍍、停車場等。



Epoxy Flooring System is formulated for professional application and especially suitable for usage in manufacturing plants & warehouse in order to generate a anti-corrosive, anti-static and easily maintenance flooring. Except from production, our company also provide turn-key services including design, application and maintenance services to provide a suitable and productive working environment for you.

## Epoxy Flooring

# Storage & Materials Handling Specialist



Part of Our Valuable Clients:  
我們的部份客戶：

愛迪達香港有限公司  
adidas Hong Kong Limited

亞洲空運中心有限公司  
Asia Airfreight Terminal Co. Ltd.

艾睿電子公司  
Arrow Asia Co. Ltd.

博士化(香港)有限公司  
Bausch & Lomb (Hong Kong) Ltd.

新濠天地  
City of Dreams

致豐國際(香港)有限公司  
DHL International (Hong Kong) Ltd.

醫院管理局  
Hospital Authority

香港歷史文化博物館  
Hong Kong History Museum

香港貿易發展局  
Hong Kong Trade Development Council

香港大學  
Hong Kong University

華為技術投資有限公司  
Huawei Tech. Investment Co. Ltd.

立邦油漆(香港)有限公司  
Nippon Paint (H.K.) Co., Ltd.

香港中華煤氣有限公司  
The Hong Kong and China Gas Company Limited

香港衛訊電訊有限公司  
Wilson Communications Ltd.

大聯六電子(香港)有限公司  
WPG Electronic (HK) Ltd.

裕利醫藥有限公司(物流中心)  
Zusellig Pharma

And more more.....  
及其他.....

**Ultra Supreme Engineering Ltd.**  
超揚工程有限公司

香港總公司  
香港九龍大角咀通州街123號國貿中心15樓C室  
Unit C, 15/F, Worldwide Centre, 123 Tung Chau Street, Tai Kok Tsui, Kln. Hong Kong.  
Tel : (852) 2309 2398, 2793 4733  
Fax : (852) 2309 1798

深圳支持部:  
電話:(755)2399 1967  
手機:18926491737  
Website: www.ultra-supreme.com



室內裝飾設計不僅是內部空間的設計造型，而且還包括“空間”與“人”之間的整合。徹底了解相關因素，才可達成完善設計方案。超揚工程有限公司借著多年經驗和訓練有素的專業人材，可以為您的問題提供合適的解決方案，以便產生協調的工作環境。其中包括：空間設計和相關設備的規劃，施工質量管理，驗收服務以及有關設施的使用，維護及對客戶的後期跟進服務等。

Interior decoration is not only referred to spacious three-dimensional planning but also including the integration between 'Space' and 'Human' through thorough going understand the related factors. After 30 years of accumulated experience and the well-trained professional team, Ultra Supreme Eng. Ltd. can provide the suitable solutions for your problems in order to generate a harmonized working environment arrange the 'Space', 'Human' and 'Facility' factors with turn-key services that provided.

The turn-key services including: Planning and Design, Implement, Quality Management, Hand-over, Maintenance and After-sales service for the related facilities & planning.



Registered Minor Works Contractor  
註冊小型工程承建商  
註冊號碼/Registration No.: MWC 252/2010



**Planning**  
To prepare functional design, which can be materialized, and plan for a workable space.  
• To understand client's legal requirement.  
• To elevate service level, health and safety impacts.  
• Problem-finding for existing facilities and propose for problem solution.  
• Ensure comply with current statutory and regulations.  
• Prepare for proposal.

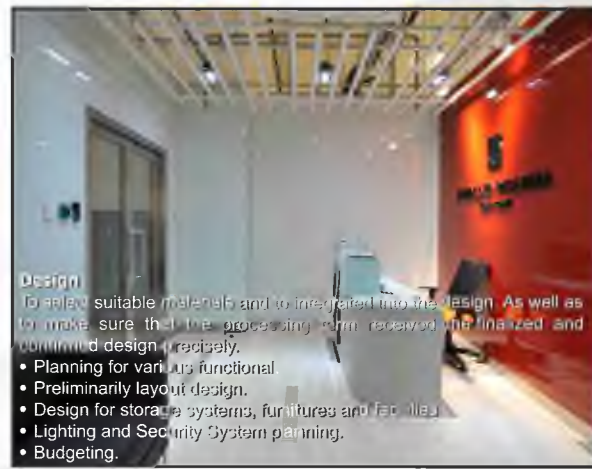

**Design**  
To select suitable materials and to coordinate the design. As well as to make sure that the proposal can be approved and finalized and confirmed design (recovery).  
• Planning for various functional.  
• Preliminary layout design.  
• Design for storage systems, furniture and facilities.  
• Lighting and Security System planning.  
• Budgeting.

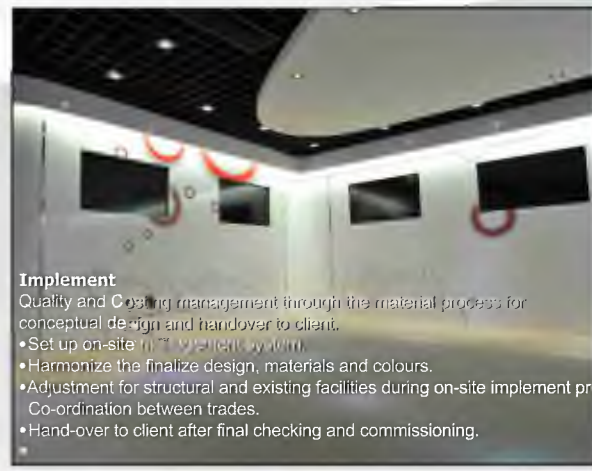

**Implement**  
Quality and Cost management through the material process for conceptual design and handover to client.  
• Set up on-site MTC (Material Control System).  
• Harmonize the finalize design, materials and colours.  
• Adjustment for structural and existing facilities during on-site implement process.  
• Co-ordination between trades.  
• Hand-over to client after final checking and commissioning.

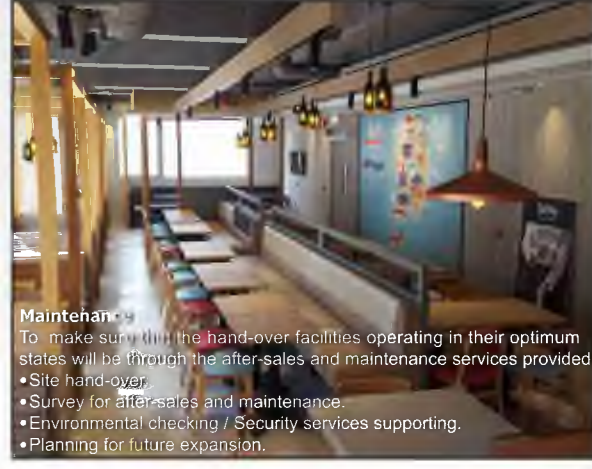

**Maintenance**  
To make sure that the hand-over facilities operating in their optimum states will be through the after-sales and maintenance services provided.  
• Site hand-over.  
• Survey for after-sales and maintenance.  
• Environmental checking / Security services supporting.  
• Planning for future expansion.

## Interior Decoration



# ULTRA SUPREME

Your turn-key consultant for warehouse office design and storage systems

### Products and services including:

- Consultancy Services
- Warehouse and Office Design Services
- Heavy Duty Pallet Racking System
- Medium Duty Longspan Shelving System
- Light Duty Modular Shelving System
- Mezzanine Platform System
- And Other Storage Systems



## Warehouse and Workshop Design 貨倉及工場設計

• Warehouse and workshop integrated in the same area with the aid of mezzanine platform, longspan shelving, modular shelving, plastic containers, work bench. It can maximize storage capacity, Good Space, Utilization and Ergonomics Design.

• 貨倉及工場皆設計於同一空間並以不同產品配合如：結構平台、中型層板貨架、輕型組件式貨架、塑膠盒子、包裝棧等做到最大存儲量，更佳空間使用方法及人體工程學設計。



## Heavy Duty Pallet Racking 重型棧板儲存貨架

- Selective Pallet Racking
- 部份百選擇式棧板儲存貨架
- Drive-in / Through Pallet Racking
- 導入式棧板儲存貨架
- Very Narrow Aisle Racking
- 超窄式通道棧板儲存貨架
- Live Pallet Storage Pallet Racking
- 動力下滑式棧板儲存貨架
- Mobile Pallet Racking
- 移動式棧板儲存貨架
- Automated Storage and Retrieval Pallet Racking System
- 自動存取/搜取式棧板儲存貨架
- Different kinds of Pallet Racking Systems to suit different requirements to maximize storage capacity and productivity
- 各種不同種類棧板儲存貨架系統可迎合不同需要以提高儲存位置及生產力



## Modular Mezzanine Platform 組件式結構平台

- Increase additional room for extra storage and office accommodation
- 有效地增加更多儲存空間或辦公室用途
- Modular design for maximum flexibility
- 靈活組件式設計



## Plastic Container System And Carousels System 塑膠盒子及輸送帶系統

- Different kinds of range, size and materials for different kind of applications
- 備有不同品種、尺碼及物料以切合不同使用需要



## 超揚工程有限公司

提供一站式貨倉/辦公室設計及儲存系統顧問服務

### 產品及服務包括:

- 顧問服務
- 倉庫及辦公室設計服務
- 重型棧板儲存貨架
- 中型層板貨架
- 結構平台
- 及其他儲存系統







超揚工程有限公司  
Ultra Supreme Engineering Ltd.

輕型貨架

Modular Shelving

扣接組合結構，層板為下方有加強鋼層板，外型美觀，不用任何螺栓，安裝拆卸方便。以 50 毫米為節距而任意調整。

Easy for assemble and disassemble by its special structure, no screw or bolt be used; each level is specially strenghtened by the reinforced supporting ribs welded under the panel which is adjustable at 50mm pitch level.



輕型貨架的層板是由鋼板組成，每層負重 100-200 公斤，主要適合存放輕小的物品。而貨架的側面及背面均可加設鐵網或鐵板圍身，以防止貨物滑下，亦可加裝分隔片使貨品擺放更有系統。

The modular shelving uses steel dividing shelf with loading capacity of 100-200 kg per level. Mainly used for storage of light weight goods. The side and the back of the modular shelving can be enclosed by wire mesh or solid steel panel. Vertical divider can also be added to make storage more organised.

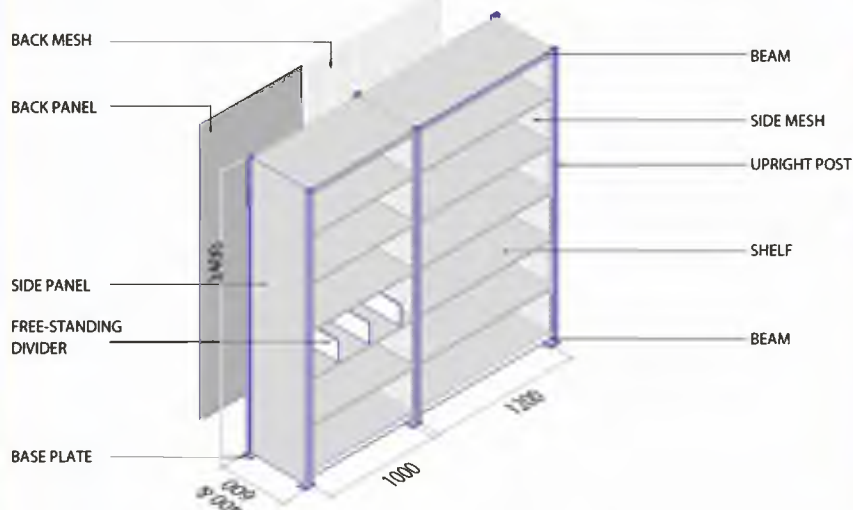

常規長度 Standard Length	1000	1200		
常規深度 Standard Depth	300	400	500	600
常規高度 Standard Height	1800	2000	2200	2400
載重 Loading	100-200KG.UDL/LEVEL			

地址：香港九龍大角咀通州街 123 號國貿中心 15 樓 C 室 Unit C, 15/F., Worldwide Centre, No.123 Tung Chau Street, Tai Kok Tsui, Kln, H.K.

Tel: (852) 2309 2398, 2793 4733 Fax: 2309 1798 Website: www.ultra-supreme.com





超揚工程有限公司  
Ultra Supreme Engineering Ltd.

中型貨架 Longspan Shelving

貨架採用扣接式結構，拆卸方便，層間距可依據貨物高度以每 50mm 為單位上下調節，其承載範圍可達 200 - 800kg / 層。層板可以選用鋼板、木板、中密板等材料。此種貨架高度適宜，方便人工存取貨物，是中小型倉庫的理想倉儲產品。

This type of storage system assemble and disassemble by its specially designed structure (no screw or bolt is used), each level can be adjustable at 50mm with a loading range between 200kg to 800kg. Steel panel, plywood and MDF panel is used for different applications. This type of rack is ideal for warehouse in medium size and small in operation by manpower.



橫梁式中型貨架  
Longspan shelving

承載重在  
200-800kg  
為中型貨架  
超過800kg  
為重型貨架

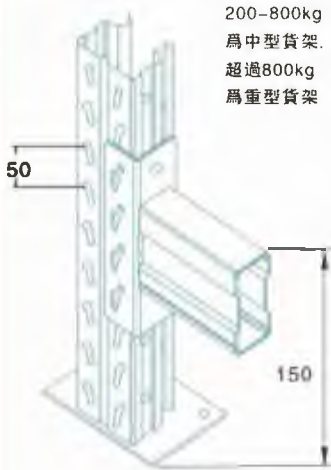

齊底焊接

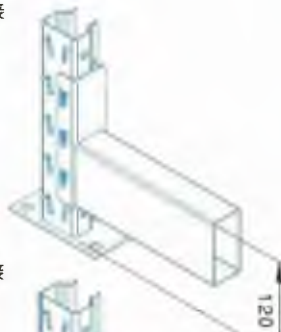

齊平焊接

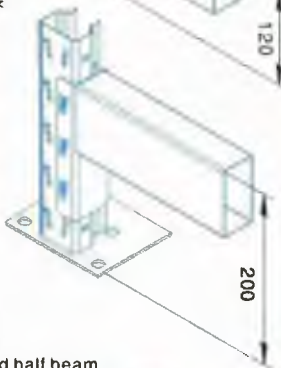

方通橫梁 (BB)  
Boxed beam

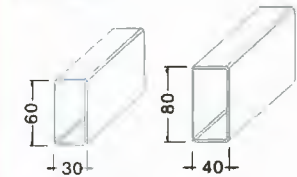

箱型橫梁 (LB)  
Two 'c' shaped half beam

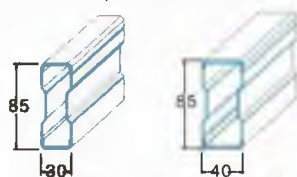

階梯橫梁 (SB)  
Stepped beam

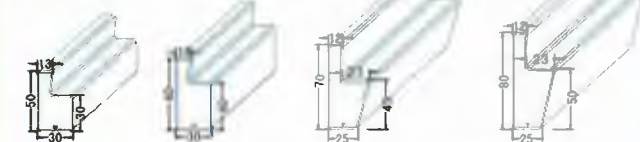

常規尺寸 Convention Size

長度 Length	1500	1800	2000	2200	2400
深度 Depth	500	600	800	1000 (三立柱)	1200 (三立柱)
高度 Height	1800	2000	2200	2500	3000
立柱規格 Upright Section Size	50*45	60*55	70*52		

注：層板物料可選購 MDF 木板，噴塑鐵板或鋼網板  
MDF wooden decking, epoxy powder coated steel panel or wire mesh panel can be selected as shelf decking.

地址：香港九龍大角咀通州街 123 號貿中心 15 樓 C 室 Unit C, 15/F., Worldwide Centre, No.123 Tung Chau Street, Tai Kok Tsui, Kln, H.K.

Tel: (852) 2309 2398, 2793 4733 Fax: 2309 1798 Website: www.ultra-supreme.com





重型橫樑式貨架 Pallet Rack



橫樑式貨架是使用最廣泛的托盤類貨物存儲系統，具有外型簡潔美觀，安全可靠，存取快速，節省空間等優點。表面外層為靜電噴粉處理，堅固耐用。層間距為 75mm 一單元上下調節，單元貨格最大承重可達 5000公斤，高度可達 12 米。

特點是存取快捷方便，適合存儲各類貨物，是企業倉庫最常用的貨架類型，適合於堆高機或叉車的操作使用。

Most widely used type of storage system, with the feature of good appearance, safe, fast in access and storage room saving. The surface was treated with epoxy powder coating which can highly increase the durability. Each level can be adjustable at 75mm interval and the maximum loading capacity is 5000kg with the maximum height of 12 meters.

This type of rack is suitable for storage of different kinds of goods with the feature of rapid loading and unloading with 100% selectivity with the aid of forklift truck.

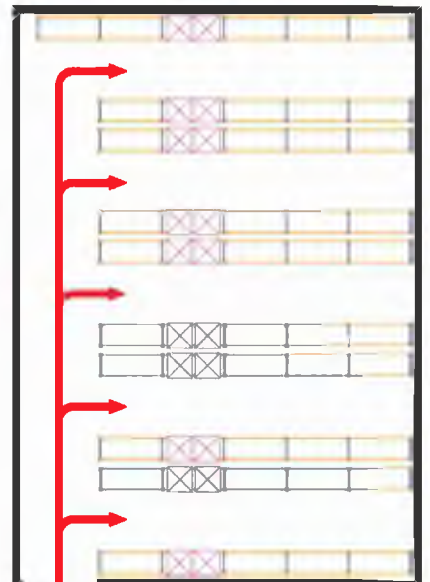

箱型橫樑截面 (LB)  
Double 'c' shaped half sections

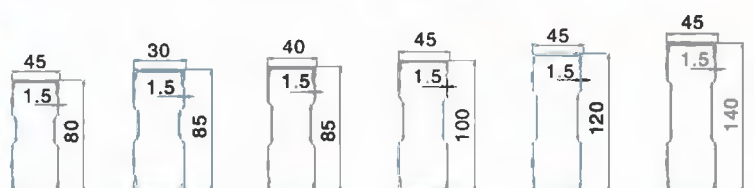





超揚工程有限公司  
Ultra Supreme Engineering Ltd.

通廊式貨架

Drive-in Rack



該系統由連續的貨架組成，中間無通道，根據貨架排列可分為單面駛入式，雙面駛入式和全通廊式。為儲存大量同類的托盤貨第而設計。

適合儲存大批量，少品種的貨物，批量作業。叉車直接駛入貨道存取貨物，作業極其方便，倉庫利用率高，能實現小空間的大存儲。常使用於冷凍倉庫、食品飲料倉庫等。



OVERHEAD BRACE  
PALLET RAIL  
FRAME BRACE  
BASE PLATE

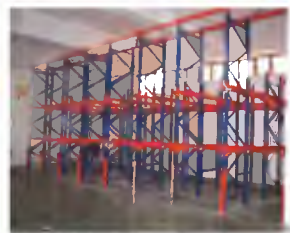
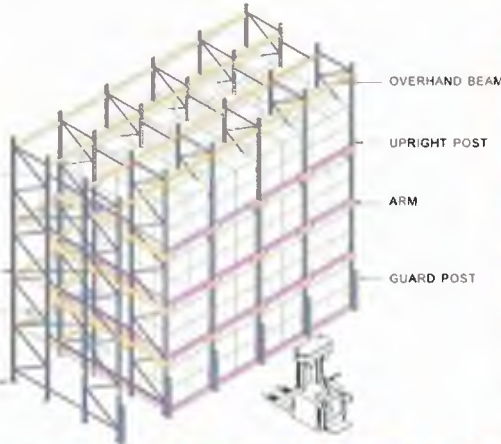

This racking system is specially designed for storage of large quantity of goods of same kind, consists of a continuous block of racking not divided by aisles and there are types: One - sided entry, Two - sided entry and Drive - through type.

Drive - in rack is widely used for cold store and food & beverage storage, where forklifts can drive directly inside the rack to access for goods, which greatly improves warehouse space utilization.

立柱雙面支臂連接

Uprights Diprosopia bars connection

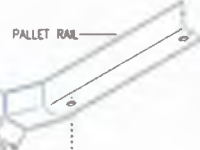
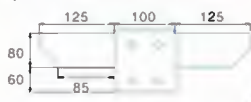

立柱單面支臂

Uprights bossed bars

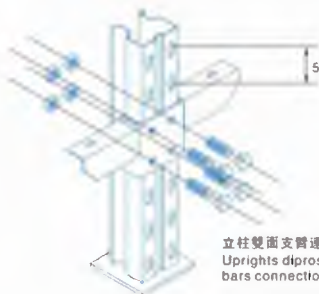

立柱雙面支臂連接  
Uprights diprosopia bars connection

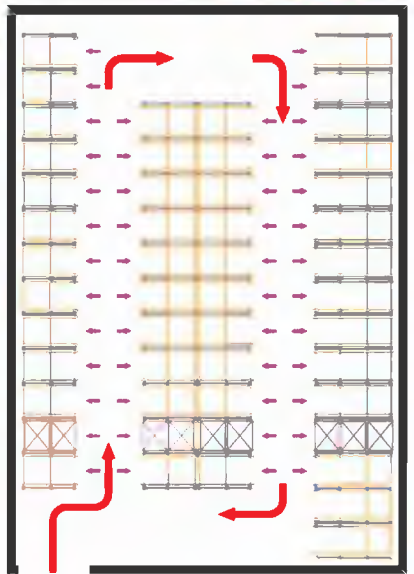





超揚工程有限公司  
Ultra Supreme Engineering Ltd.

雙深度貨架

Double-deep Rack

- 雙深度貨架系列是由重型橫樑式貨架衍生而成
- 結構簡便· 儲存量高· 而有效地緩解普通橫樑式貨架不能滿足的儲存要求
- 比普通橫樑式貨架增加一倍的存貨量
- 此類貨架比較適合煙草、食品飲料、包裝等行業選用



側面立柱片有擱板連接

- Double-deep rack derived from selective type pallet rack.
- Simple structure, high storage capacity, meet with different storage requirements which selective type racks can not do.
- Double storage capacity than common selective type racks.
- Applicable to storage of cigarette, food & beverage, packing, etc.

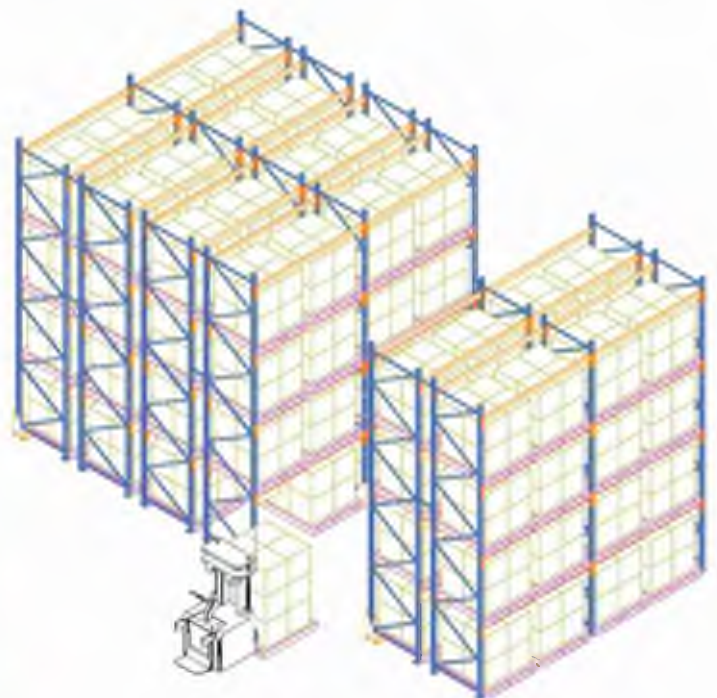
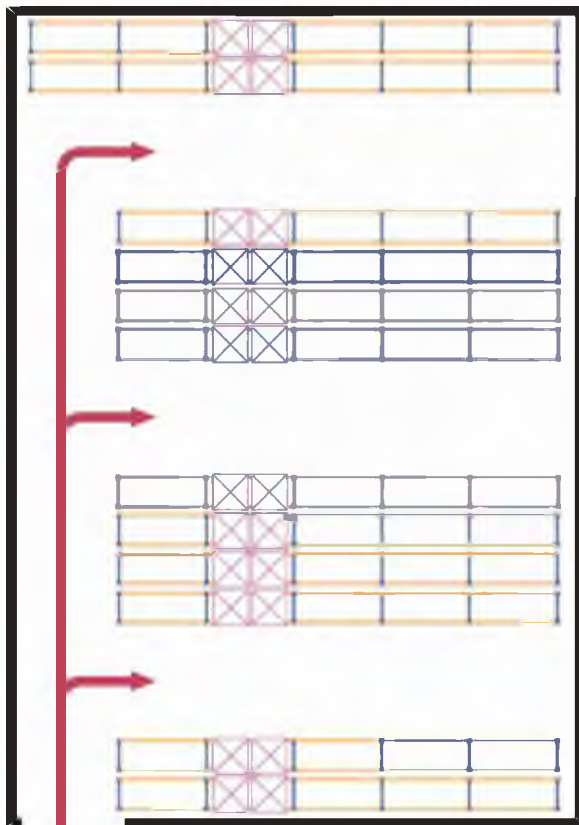





超揚工程有限公司  
Ultra Supreme Engineering Ltd.

閣樓式貨架 Mezzanine Floor

這系統廣泛應用於庫房較高、貨物體積較小、人工存取、存儲量較大的情況，也適用於現有舊倉庫的技術改造，可提高倉庫的空間利用率，充分利用空間，節約庫房面積，根據實際場地和具體要求，可設計成單層或多層閣樓平台，一般為 2 - 3 層，配備樓梯、扶手和貨物升降機等。特別適用於汽配、電子器件等企業系列產品的分類保存，承載500kg/m。貨物至二樓或三樓的運輸方式通常有：人工、升降平台、升降機、輸送帶、叉車等。

Mezzanine floor are widely used in warehouses with high ceiling height where goods are small in size but in large quantity operated by manpower. It can improve warehouse space utilization and save floor area. It is usually 2 or 3 levels high equipped with stairs and handrail, loading gate and sometime whitt goods elevator.

This type is especially applicable for storage of automobiles components, electronic products. The loading is  $\leq 500\text{kg}$  per square meter and goods can be handled by manpower, through elevator, conveyer belt and forklift.

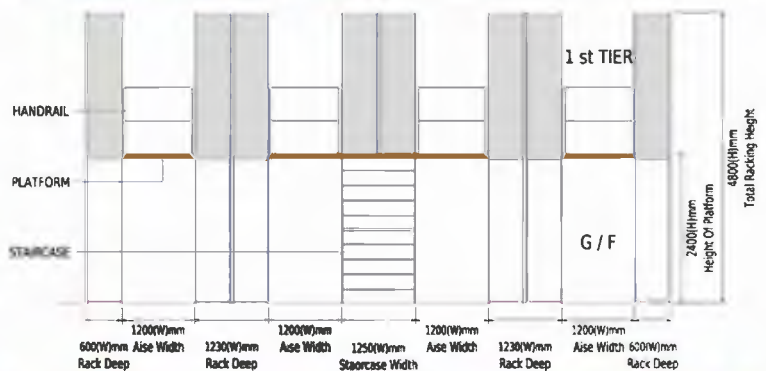
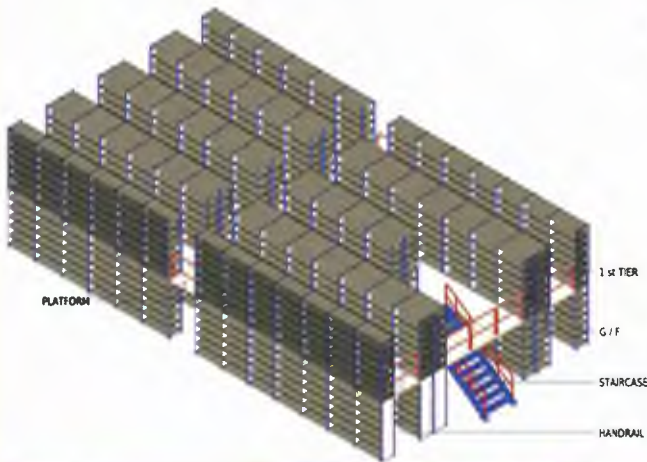

地址：香港九龍大角咀通州街 123 號國貿中心 15 樓 C 室 Unit C, 15/F., Worldwide Centre, No.123 Tung Chau Street, Tai Kok Tsui, Kln, H.K.

Tel: (852) 2309 2398, 2793 4733 Fax: 2309 1798 Website: www.ultra-supreme.com



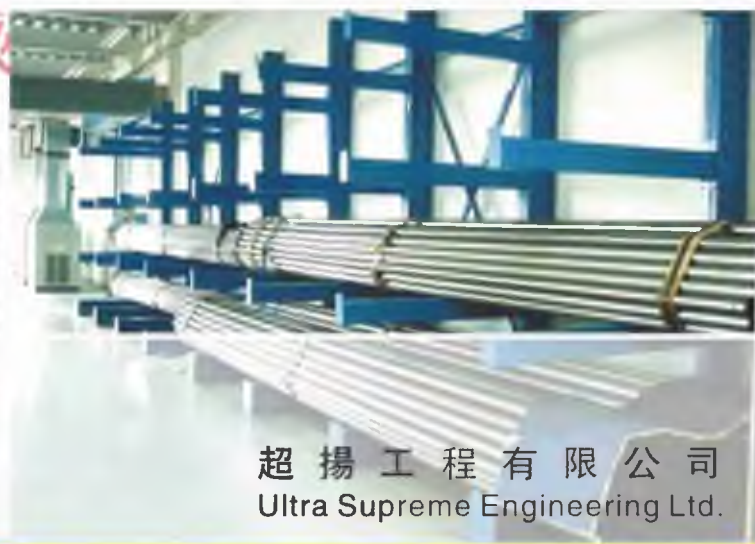
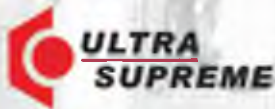

超揚工程有限公司  
Ultra Supreme Engineering Ltd.

懸臂式貨架 Cantilever Rack

懸臂式貨架有單臂和雙臂之分，專用立柱型材，可加背牆拉杆，以增強穩固，高強度的懸臂，每組臂承重可達 2 噸以下，高度以每 100 毫米為一單元上下調節。組合式結構更為方便輕巧，載重能力好，空間利用率高，等優點；適合空間小，高度低的庫房，管理方面，視野寬闊，常用於長物料、板材、環型物料和不規則的貨物存儲。

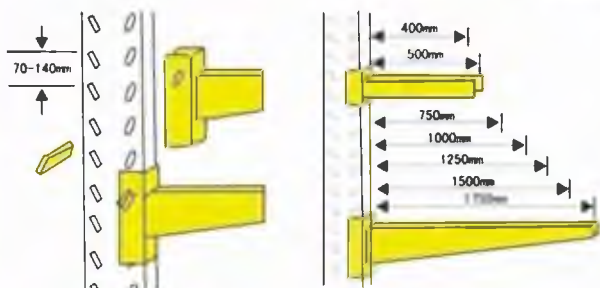

Cantilever rack has two types: one side lever and double side, uprights are unique with a special design of reinforcement. Levers can bear weight of 2 tons with an adjustable height at 100mm per pitch.

This type has features of ease in operation with high loading, good warehouse space utilization and is suitable for warehouse which has small ground floor and low height. It is easy for goods management with wide view for operator, and is often used for goods of panels, ring-shape materials, long length and goods of irregular shape.

鐵網架 Mesh Panel & Louvred Panel

鐵網結構為 50 x 50 x 4mm，鐵絲網與定縫釘和螺絲均為銀色噴塗，配備特別勾子零件，整體尺寸為 1000mm 寬，2000mm 高。

Manufactured in structural steel, 50 x 50 x 4mm, painted with silver-grey and supplied completer with dowels and screws. Various storage combinations are possible with special hook for long parts. Dimensions: 1000mm wide, 2000mm high.

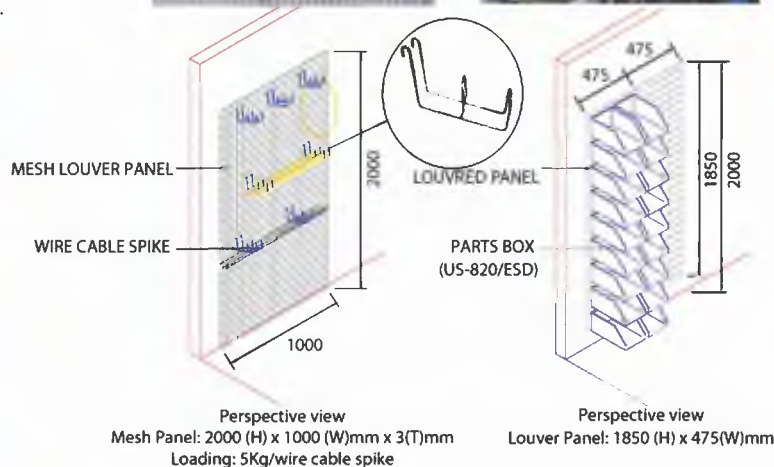

地址：香港九龍大角咀通州街 123 號國貿中心 15 樓 C 室 Unit C, 15/F., Worldwide Centre, No.123 Tung Chau Street, Tai Kok Tsui, Kln, H.K.

Tel: (852) 2309 2398, 2793 4733 Fax: 2309 1798 Website: www.ultra-supreme.com





超揚工程有限公司  
Ultra Supreme Engineering Ltd.

鐵網圍網間隔 Wire Mesh Fencing

鐵網圍網間隔系統可適合使用在任何地方上，由於它的原料有不同的寬度，所以可以隨意組合連接為任何的空間。網門的開向可自由選擇裝配左右兩面，另可選擇滑動門設計。

產品款式尺寸繁多，歡迎致電查詢

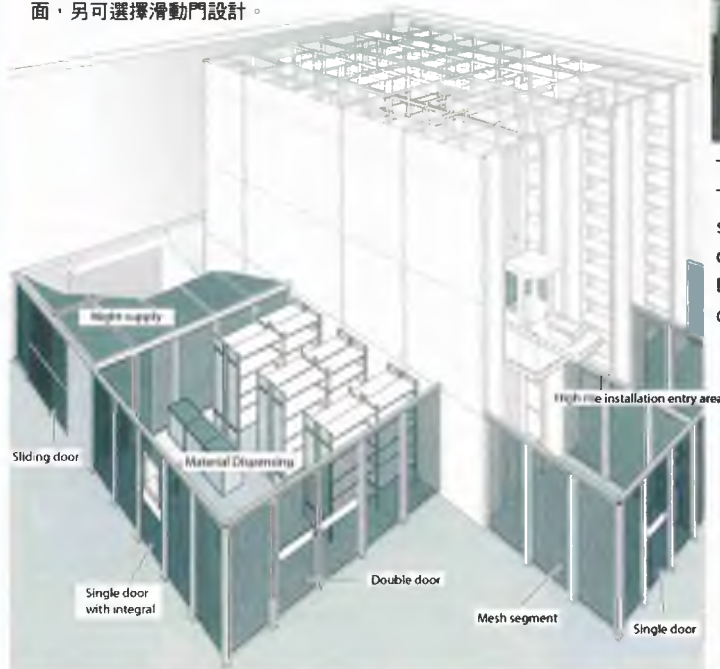

The wire mesh fencing systems are designed to match the shelving system. These systems can be used anywhere, either in conjunction with a shelving system, for order picking levels or as free-standing fencing. The elements come in different widths, height and colour.

Door can be changed from left-hung to right-hung or vice versa without difficulty and sliding type can also be an option.

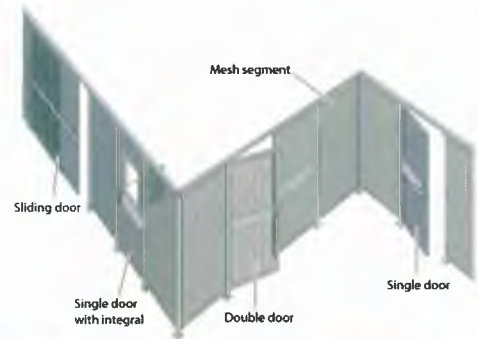

地址：香港九龍大角咀通州街 123 號國貿中心 15 樓 C 室 Unit C, 15/F., Worldwide Centre, No.123 Tung Chau Street, Tai Kok Tsui, Kln, H.K.

Tel: (852) 2309 2398, 2793 4733 Fax: 2309 1798 Website: www.ultra-supreme.com





超揚工程有限公司  
Ultra Supreme Engineering Ltd.

### 流利式貨架 Flow Racking Systems

使用的流利式貨架系統可以方便地訪問產品將機架傾斜。紙箱流道提供產品的組織。產品使用FIFO（先入先出）的庫存控制方法拾取。



Used flow racking systems allows the rack to slant forward for easy access to product. Carton flow lanes provide organization of product. Product is picked using the FIFO (First In, First Out) method of inventory control.



### 活動文件櫃 Mobile Shelving System

移動存儲系統可以幫助提高空間效率80%。該系統可以手拉著，機械輔助或電子通電的易用性。隨著客戶要求及合適尺寸，該系統可滿足任何存儲的要求。

Mobile storage systems can help improve space efficiency by 80%.

The system can be hand pulled, mechanically assisted or electronically powered for ease of use.

With a range of made to measure shelving and client requirement, the system can meet any







超揚工程有限公司  
Ultra Supreme Engineering Ltd.

**安全防撞欄 Safety Barrier**

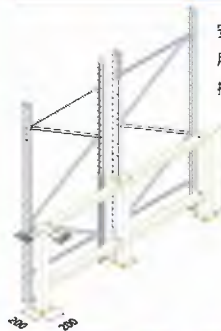

安全防撞欄可作保護貨架用途，以防止鏟車直接碰撞貨架。

The safety barrier is a heavy duty type protector used to protect the side of the racking system from directly hit by forklift truck.

**角型防撞柱 Corner Guard**



角型防撞柱的設計是可以防止鏟車從前面和左面或右面兩方向的直接碰撞。

The corner guard is a light duty type protector for the upright post.

**U型防撞柱 U-Column Guard**



U型防撞柱的設計是可以防止鏟車從左右前三方面的直接碰撞。

The column guard is a all round medium type protector for the lower leg of the upright post.

**防撞企柱 Standard Drive-in Guard Post**



防撞企柱置放在貨架企柱前方，可作加強保護貨架，以防止鏟車的碰撞。

Used to strengthen the front uprights and to afford protection against impact.



**鐵網籠 Security Metal Cages**

鐵網籠可隨客戶需要擺放卡板或層板。

Mesh cage can match the customers requirement to placed pallet or decking







超揚工程有限公司  
Ultra Supreme Engineering Ltd.

產品款式尺寸繁多，歡迎致電查詢

物流籠車 Roll Pallets

物流籠車以圓管及冷軋鋼片組成，強化的底部使操作更穩定，可加鋼板及木層板，不使用時可折合，節省空間。

Roll pallets constructed from rigid tubular steel rod and cold-rolled steel plate. The reinforced wiremesh base assures great strength during operations.

Roll pallets could be folded up when not in use for space saving.



External: 740(W) x 840(D) x 1720(H)  
Wheels: 125mm Dia  
Capacity: 600kg



External: 735(W) x 830(D) x 1720(H)  
Wheels: 125mm Dia  
Capacity: 600kgs



External: 715(W) x 800(D) x 1520(H)  
Wheels: 100mm Dia  
Capacity: 500kgs



External: 700mm(d) x 1000mm (W) x 1800mm(heart)



External: 900mm(d) x 900mm (W) x 2400mm(heart)

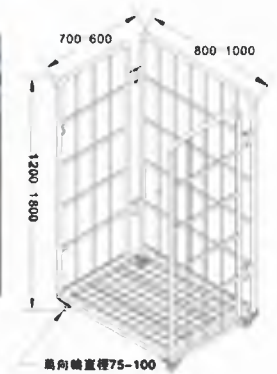

樓梯車/手推車 Ladder Trolley / Trolley

這些手推車可以容易地通過狹窄和彎曲的通道。適合任何辦公室及貨倉使用。

These trolleys can be pushed along effortlessly-even through narrow passageway and sharp bends. Suits any office and warehouse usage.

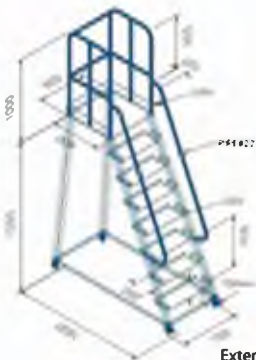

External: 1600(L) x 700(W) x 2500(H)



External: 6000 x overall 1700H x 1300Lmm (platform 1000H x 850Wmm)



External: 6000 x overall 1700H x 1450mm (platform 1000H)



External: 740(L) x 480 (W) x 820 (H)  
Capacity: 125kg



External: 1070(L) x 610 (W) x 990 (H)  
Capacity: 200kg



External: 1000(L) x 700 (W) x 950 (H)  
Capacity: 250kg



External: 998(L) x 695 (W) x 1000 (H)  
Capacity: 500kg

地址：香港九龍大角咀通州街 123 號國貿中心 15 樓 C 室 Unit C, 15/F., Worldwide Centre, No.123 Tung Chau Street, Tai Kok Tsui, Kln, H.K.

Tel: (852) 2309 2398, 2793 4733 Fax: 2309 1798 Website: www.ultra-supreme.com





超揚工程有限公司  
Ultra Supreme Engineering Ltd.

產品款式尺寸繁多，歡迎致電查詢

工作檯/工作站 Workbenches / Workstations

正確的工作檯高度能極大減少勞損，達到你理想的工作高度而且容易調整。

The suitable working height can significantly reduces strains. Ideal working height can be achieved with these easily adjustable workstations.

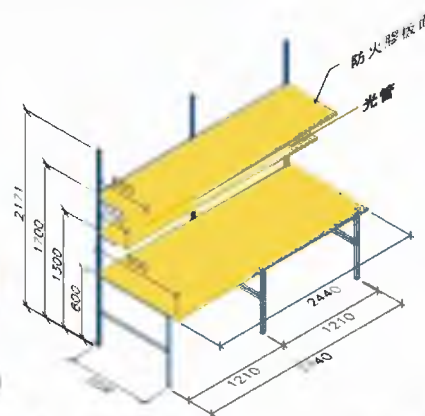
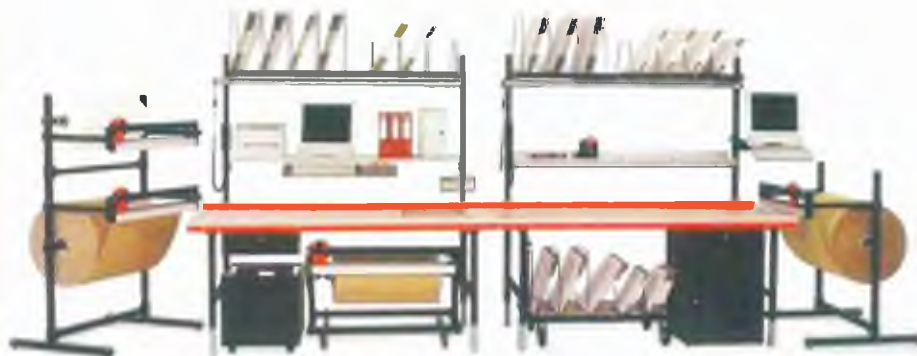

Dimension : 1830mmL x 910mmD x 1875mmH

Dimension : 2400mmL x 1000mmD x 900mmH

地址：香港九龍大角咀通州街 123 號國貿中心 15 樓 C 室 Unit C, 15/F., Worldwide Centre, No.123 Tung Chau Street, Tai Kok Tsui, Kln, H.K.

Tel: (852) 2309 2398, 2793 4733 Fax: 2309 1798 Website: www.ultra-supreme.com





超揚工程有限公司  
Ultra Supreme Engineering Ltd.

塑料托盤

Plastic Pallets

注:以下尺寸單位均為mm Size : Metric (mm)



動載: 1.5T 靜載: 4T 貨架: 1.2T  
尺寸: 1200 X 1000 X 170

US-1210F  
川字底單網格面型  
(內置鋼管)

動載: 1T 靜載: 3T 貨架: 0.6T  
尺寸: 1200 X 1000 X 155

US-1210F (B)  
田字底單網格面型



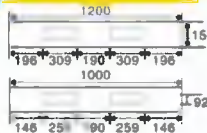

動載: 1T 靜載: 3T 貨架: 0.75T  
尺寸: 1100 X 1100 X 170

US-1111F  
川字底單網格面型

動載: 0.75T 靜載: 2T  
尺寸: 1200 X 800 X 120

US-1218F(B)  
九腳底單網格面型

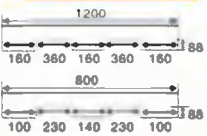

動載: 1T 靜載: 3T 貨架: 0.75T  
尺寸: 1200 X 800 X 125

US-1208F (B)  
川字底單網格面型



動載: 0.75T 靜載: 2T  
尺寸: 1100 X 1100 X 125

US-1111F (B)  
九腳底單網格面型



塑料物流箱

Pallet Transport Containers



外尺寸 Extr Size	1200 x 1000 x 760mm	貨架 Rack	1.2T
內尺寸 Intr Size	1110 x 910 x 600mm	動載 Dynamic	1T
款式 Entry	四邊通叉 Four-Way	靜載 Static	4T
		零件號 Part No	ZL01358772 2



External : 1200mmL x1000mmD x 760mmH



外尺寸(mm) 540x395x255  
內尺寸(mm) 495x350x220



外尺寸(mm) 600x395x350  
內尺寸(mm) 550x365x330

地址: 香港九龍大角咀通州街 123 號國貿中心 15 樓 C 室 Unit C, 15/F., Worldwide Centre, No.123 Tung Chau Street, Tai Kok Tsui, Kln, H.K.

Tel: (852) 2309 2398, 2793 4733 Fax: 2309 1798 Website: www.ultra-supreme.com





**ULTRA  
SUPREME**



超揚工程有限公司  
Ultra Supreme Engineering Ltd.

組合零件盒+輕型貨架

Parts Box + Modular Shelving



輕型貨架因應需要可擺放不同的組合零件盒，亦可隨意調節每層層板的高度，調節間距為25mm。

The modular shelving can place component part boxes in different size and each shelf can be vertically adjusted at spacing of 25mm at will.

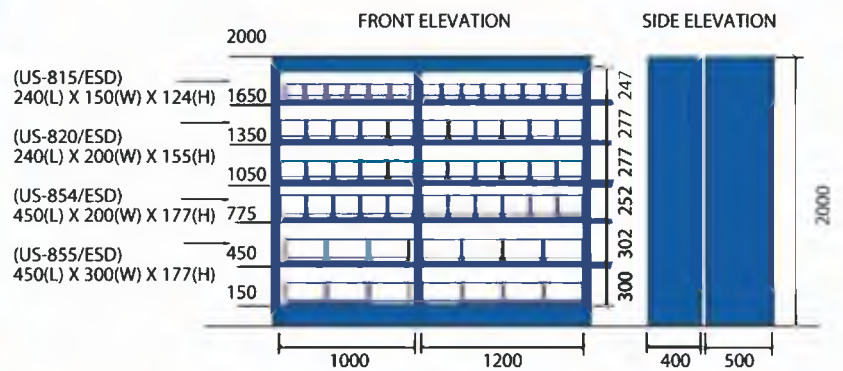

LOADING CAPACITY  
SHELF: 300 / 400 / 500(D) X 1000 / 1200(W)mm c/e  
LOADING: 100 or 200 kg / pair shelf UDL



地址：香港九龍大角咀通州街123號國貿中心15樓C室      Unit C, 15/F., Worldwide Centre, No.123 Tung Chau Street, Tai Kok Tsui, Kln, H.K.

Tel: (852) 2309 2398, 2793 4733      Fax: 2309 1798      Website: www.ultra-supreme.com





超揚工程有限公司  
Ultra Supreme Engineering Ltd.

產品款式尺寸繁多，歡迎致電查詢

組合零件盒/防靜電箱 Parts Box / ESD Box

注：以下尺寸單位均為mm Size: Metric (mm)



尺寸：L450 X W300 X H177  
US-855 / ESD



尺寸：L450 X W200 X H177  
US-854 / ESD



尺寸：L340 X W200 X H155  
US-820 / ESD



注：有紅、黃、藍、黑(ESD)四種顏色

元件盒 (大號)  
Element Box (Big)

尺寸：L140 X W120 X H65

元件盒 (小號)  
Element Box (Small)

尺寸：L95 X W100 X H50



尺寸：L240 X W150 X H124  
US-815 / ESD



尺寸：L190 X W130 X H100  
US-812 / ESD



尺寸：L160 X W100 X H74  
US-810 / ESD



可任意組合，方便調整  
Can be fixed each other

上下支撐

每盒可立四支高柱，用以撐高重疊使用，增加空間取物便捷運  
Can be extended the height between Two (2) boxes by Four (4), extra rods to get more space for storing goods.

組合零件盒/防靜電箱 Electronic Component Drawer Cabinet



HS-2405-B/H310xW460xD230/抽屜量：20層



HS-2515-A/H940xW577xD214/抽屜量：75層



HS-1412D-A(左右開門附鎖)  
H990xW645xD280/抽屜量：48層



HS-3310D-A(左右開門附鎖)  
H990xW465xD2820/抽屜量：30層



HS-3304-A/H370xW550xD300/抽屜量：12層



地址：香港九龍大角咀通州街 123 號國貿中心 15 樓 C 室 Unit C, 15/F., Worldwide Centre, No.123 Tung Chau Street, Tai Kok Tsui, Kln, H.K.

Tel: (852) 2309 2398, 2793 4733 Fax: 2309 1798 Website: www.ultra-supreme.com





產品款式尺寸繁多，歡迎致電查詢

塑料零件盒 Plastic Containers



型號：USJQ-3011 分隔物料盒

External: 300 x 117 x 90mm 單箱承重 ≈ 5kg  
Internal: 260 x 94 x 80mm 堆碼承重 ≈ 20kg  
容量：2L 材質：抗衝擊改性PP  
可選配橫向分隔片



型號：USJQ-4011 分隔物料盒

External: 400 x 117 x 90mm 單箱承重 ≈ 10kg  
Internal: 360 x 94 x 80mm 堆碼承重 ≈ 40kg  
容量：2.7L 材質：抗衝擊改性PP  
可選配橫向分隔片



型號：USJQ-5011 分隔物料盒

External: 500 x 117 x 90mm 單箱承重 ≈ 8kg  
Internal: 460 x 94 x 80mm 堆碼承重 ≈ 32kg  
容量：3.5L 材質：抗衝擊改性PP  
可選配橫向分隔片



型號：USJQ-3023 分隔物料盒

External: 300 x 234 x 90mm 單箱承重 ≈ 9kg  
Internal: 256 x 211 x 80mm 堆碼承重 ≈ 36kg  
容量：4.4L 材質：抗衝擊改性PP  
可選配橫向分隔片



型號：USJQ-4023 分隔物料盒

External: 400 x 234 x 90mm 單箱承重 ≈ 13kg  
Internal: 356 x 211 x 80mm 堆碼承重 ≈ 52kg  
容量：6L 材質：抗衝擊改性PP  
可選配橫向分隔片



型號：USJQ-5023 分隔物料盒

External: 500 x 234 x 90mm 單箱承重 ≈ 15kg  
Internal: 456 x 211 x 80mm 堆碼承重 ≈ 60kg  
容量：7.8L 材質：抗衝擊改性PP  
可選配橫向分隔片



型號：USJQ-6023 分隔物料盒

External: 600 x 234 x 90mm 單箱承重 ≈ 15kg  
Internal: 556 x 211 x 80mm 堆碼承重 ≈ 60kg  
容量：9.4L 材質：抗衝擊改性PP  
可選配橫向分隔片



型號：USJQ-3023H 分隔物料盒

External: 300 x 234 x 140mm 單箱承重 ≈ 11kg  
Internal: 253 x 210 x 129mm 堆碼承重 ≈ 44kg  
容量：7.1L 材質：抗衝擊改性PP  
可選配橫向分隔片



型號：USJQ-4023H 分隔物料盒

External: 400 x 234 x 140mm 單箱承重 ≈ 14kg  
Internal: 353 x 210 x 129mm 堆碼承重 ≈ 56kg  
容量：9.9L 材質：抗衝擊改性PP  
可選配橫向分隔片



型號：USJQ-5023H 分隔物料盒

External: 500 x 234 x 140mm 單箱承重 ≈ 18kg  
Internal: 553 x 210 x 129mm 堆碼承重 ≈ 72kg  
容量：12.6L 材質：抗衝擊改性PP  
可選配橫向分隔片



型號：USJQ-6023H 分隔物料盒

External: 600 x 234 x 140mm 單箱承重 ≈ 23kg  
Internal: 553 x 210 x 129mm 堆碼承重 ≈ 95kg  
容量：15.4L 材質：抗衝擊改性PP  
可選配橫向分隔片







超揚工程有限公司  
Ultra Supreme Engineering Ltd.

運輸設備

Transport Equipment



Hand Pallet Truck



Stock Chaser



Electric Pallet Stackers



Forklift Truck

防火安全儲物櫃

Ex Safety Cabinets

High Performance Safety Cabinets

OSHA compliant, meet NFPA Code 30  
and are independently tested and approved by FM



Size: 65" x 43" x 34" ( 1651H x 1092W x 864Dmm )

- Double-wall construction with 1-1/2" (38mm) insulating air space.
- Sundry 18-gauge (1mm) steel, welded for strength, long life and greater fire protection.
- Exclusive U\*Loc® handle includes two keys and accepts an optional padlock for convenience and security. Easy fingertip operation with slip resistant grip for greater control.
- Exclusive Haz-Alert® reflective labeling for high visibility under fire conditions or power outage. Strategically zone positioned to be firefighter friendly.
- 3-pt, stainless steel bullet latching system for optimum longevity with increased heat resistance.
- Exclusive SpillSlope® shelves safely direct spills to bottom of sump. Adjustable on 3" centers for versatile storage. Made of sturdy galvanized steel, they meet ANSI standards with a 350lb. (159kg) safe allowable load.
- Self-latching, easy close doors on piano hinge for smooth operation
- Rounded safety corners on doors.
- 2" (51mm) leakproof sump to contain spills.
- Dual 2" (51mm) vents with flame arresters.
- Durable lead-free powder paint finish, inside-and-out, for maximum chemical resistance.
- Built-in grounding connector prevents static build up
- Four adjustable leveling feet provide a wobble-free base
- Warning label in three languages: English, Spanish, French
- Attractive, flush mounted handle design reduces dangerous "catches" from passing traffic. Less prone to damage when shipped.
- Self-close style features fusible links to hold doors open and patented, concealed self-close mechanism for obstruction-free access.
- Quality backed by an industry 1st, Ten-Year Warranty.



Size : 889mmD x 1092mmW x 1651mmH

地址：香港九龍大角咀通州街 123 號國貿中心 15 樓 C 室 Unit C, 15/F., Worldwide Centre, No.123 Tung Chau Street, Tai Kok Tsui, Kln, H.K.

Tel: (852) 2309 2398, 2793 4733 Fax: 2309 1798 Website: www.ultra-supreme.com





超揚工程有限公司  
Ultra Supreme Engineering Ltd.

活動工具車 Movable Tools Carts



External: 1000(L)x500 (W) x960(H)



铝制老虎車

型号	載重 (kg)	叉板尺寸 (mm)	整車尺寸 WxDxH(mm)
KLH-01	300	355x190	420x510x1260
KLH-02	300	355x190	420x510x1330

儲物櫃 Locker



Description : 6 Doors Locker ( 2 x 3 )  
Size: 900W x 480D x 1800Lmm



Description : 8 Doors Locker ( 4 x 2 )  
Size: 880W x 400D x 1800Lmm

膠垂直簾 PVC Curtain



工具櫃 Tool Cabinet





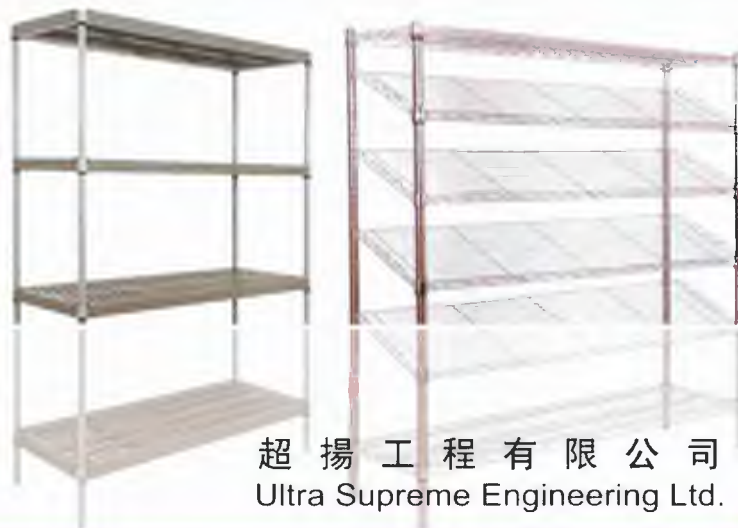

超揚工程有限公司  
Ultra Supreme Engineering Ltd.

### 層架系列GDJNZ Shelving System Series GDJNZ

Name: 4 tiers Stainless steel wire shelf / Chromed Plated Wire Shelf  
Material: 201 Grade stainless steel (S/S 304 and 430 Available)  
/ Chrome plated steel  
Wire Diameter:  $\phi$  6.0/5.0/4.5/3.5mm  
Post Diameter:  $\phi$  25.4mm\*1.2mm Thickness  
Different combination according to your requirement  
Loading Capacity: 200 Kilogram per shelf  
Height adjustment in 1" (25mm), castors available  
Strong and durable, use for any place  
Five years guarantee

型號: 4層不銹鋼層架 / 4層鍍鉻層架  
材料: 不銹鋼201 (也可根據客戶需要用304不銹鋼或430不銹鋼) / 鍍鉻  
網片綫材:  $\phi$  6.0/5.0/4.5/3.5mm  
支柱直徑和厚度:  $\phi$  25.4mm\*1.2mm厚  
每套層架包括四層架子和4個支柱以及卡套  
可按個人需要, 對風格及空間結構進行設計組合  
每層層架的承重量: 200公斤  
可隨意按1" (25mm)調整層網/板高度 (可根據實際需要加滑輪)  
耐腐蝕性強, 歷久常新, 堅固耐用, 非特殊要求環境均適合使用  
保質期: 5年 / 1年



### 導軌式存儲系列GDJNZ Top Track Storage System GDJNZ

Each of shelving system can be used as part of a high density. Active aisle storage solution that can increase the storage capacity of a given area by up to 50%

The "Top track System" Utilizes a guiding track that is mounted above. The Shelving for applications where cleanliness is important. Adjustable shelves and feet: (castors available)

無論有多少座層架, 祇需在并排的層架車中, 移出一條通道, 便可以很方便的存取物品, 使儲存面積大幅度提升, 使用的層架車越多, 空間提升率越高, 適合大儲存量及活動率高的地方。

所有標準規格的層架, 均可以組成活動系統, 多種長度的導軌, 令系統長度可以無限延伸, 并可因應不同的地方需求, 設計出最大的利用率。



### 組合貨架系列GDJNZ Combination shelf series GDJNZ

Name: 6 tiers Chrome Slanted Sheet Display  
Model No. D1436-C  
Unit Size: 355\*910\*1590mm  
Material: Chrome plated steel (Other materials are available)  
Slant shelf in 45°C, provide a better visibility of displayed product.  
Also can be assemble with standard shelf  
Different combination according to your requirement  
All wire shelves or solid flat shelf can be use together  
Height adjustment in 1" (25mm), castors available

名稱: 6層鍍鉻展示架  
型號: D1436-C  
尺寸: 355\*910\*1590mm  
材料: 鍍鉻 (也可用其它材料)  
45度斜展示層架, 視覺效果更佳  
也可配標準網片使用  
可按個人需要, 對風格及空間結構進行設計組合  
綫網/鋼板可混合組裝使用  
可隨意按1" (25mm) 調整層網/板高度 (可根據實際需要加滑輪)







超揚工程有限公司  
Ultra Supreme Engineering Ltd.

噴粉層架GDJNZ Powder Coated Wire Shelf Colophony Wire Shelf GDJNZ

Name: 6 tiers Powder coated wire shelving / 4 tiers Powder coated wire shelving  
Material: Powder coated steel  
Wire Diameter:  $\phi$  6.3/5.0/4.5/3.5mm  
Post Diameter:  $\phi$  25.4mm\*1.2mm Thickness  
Different combination according to your requirement  
Loading Capacity: 200 Kilogram per shelf  
Height adjustment in 1" (25mm), castors available  
Steel material with special colophony coating, rust-proof, moistureproof, acid proofing, alkali prevention, suit able -40°C to 150 °C.  
Any Colour is available  
Two Year guarantee / One Year guarantee

型號: 6層噴粉層架 / 4層噴粉層架

材料: 噴粉

網片線材:  $\phi$  6.0/5.0/4.5/3.5mm

支柱直徑和厚度:  $\phi$  25.4mm\*1.2mm厚

可按個人需要, 對風格及空間結構進行設計組合

可以自由選擇層架的層數

每層層架的承重量: 200公斤

可隨意按1" (25mm)調整層網/板高度 (可根據實際需要加滑輪)

防銹能力強, 並防潮、酸、碱及腐蝕, 耐高低溫(-40 °C至150 °C)

可根據客戶要求, 定制各種顏色噴粉層架。

保質期: 2年 / 1年



塑料組合貨架GDJNZ Polymer Shelving/Plastic Shelving GDJNZ

Name: Polymer shelving (GAL. + Powder coated)  
Material: Polymer shelves with galvanized first and then powder coated steel frame and post  
Load capacity: 250 kilogram per shelf (550 pounds per shelf)  
Easy to wash, removable plastic shelves  
Different combination according to your requirement  
Non deformable during -50 °C to 100 °C  
Fungi proofing  
Height adjustment in 1" (25mm), castors available

名稱: 塑料組合層架 (鍍鋅+噴粉框架, 支柱)

材料: 高分子聚合物塑料網片

框架, 支柱表面處理: 鍍鋅+噴粉

承重量: 每層層架的承重量: 250公斤

可拆式塑料網

可按個人需要, 對風格及空間結構進行設計組合

衛生抗菌, 耐高低溫-50 °C 至 100 °C

適用於冷庫儲存

可隨意按1" (25mm)調整層網/板高度 (可根據實際需要加滑輪)

洗滌設備 Washing Facilities SHHM



帆布布草車  
產品尺寸: 900 × 650 × 850mm



塑料籠車  
產品尺寸: 1100 × 720 × 1700mm  
塑料籠車 (層板不用時可以當擋板)



環保塑料儲物架  
產品尺寸: 1220 × 530 × 1800mm  
1525 × 530 × 1800mm





超揚工程有限公司  
Ultra Supreme Engineering Ltd.

工程及項目參考 Project Reference Photos







超揚工程有限公司  
Ultra Supreme Engineering Ltd.

工程及項目參考 Project Reference Photos





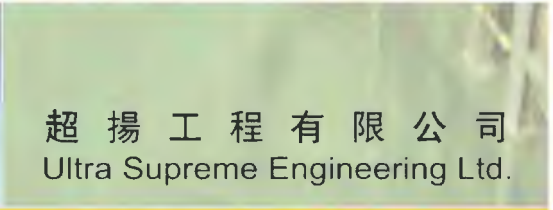

超揚工程有限公司  
Ultra Supreme Engineering Ltd.

### Heavy Duty PVC Floor Tile

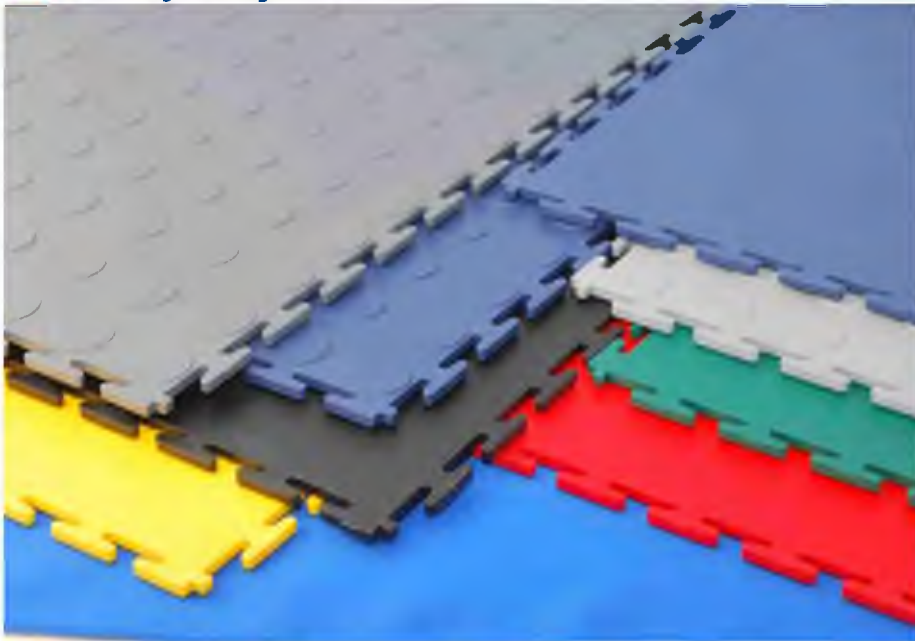

### 環氧樹脂無縫地臺漆 Epoxy Flooring



地址：香港九龍大角咀通州街 123 號國貿中心 15 樓 C 室 Unit C, 15/F., Worldwide Centre, No.123 Tung Chau Street, Tai Kok Tsui, Kln, H.K.

Tel: (852) 2309 2398, 2793 4733 Fax: 2309 1798 Website: www.ultra-supreme.com





超揚工程有限公司  
Ultra Supreme Engineering Ltd.

## 環氧樹脂無縫地臺漆

### Epoxy Flooring

Epoxy Flooring Anti-static Epoxy Flooring, Polyurethane Coating, Water-based polyurethane Coating Acrylic Enamel, etc. That is widely used in the area of civil construction, flooring, stadium, etc. Apart from supplying to the local projects, it is also exported to other Asian countries

環氧樹脂, 水性環氧樹脂, PU聚氨基甲酸乙酯等特殊塗料。廣泛使用於工業地臺, 貨倉、運動場及停車場。除供應本地之產業外, 更外銷至中國、東南亞等多個地區及國家, 且獲各界客戶一致的好評及肯定。為求公司的永遠向前經營及拓展精神, 并關注生態環境保護, 我公司在近來積極研發減少對環境生態有污染之塗料, 因此我公司投入更多人力, 物力致力於水性Epoxy及 PU, 從而減少對自然生態的損害。

## 基礎工程施工之要求

### Requirements for primer application:

**Foundation:** Design data reference for levelness, water drainage levelness and thickness.

**基礎層:** 平坦度、洩水坡度及厚度依設計師數據參考設計。

**Superstructure:** Water-proof treatment required so as to prevent the negative influence or even destroying the application of epoxy flooring by increment of water level.

**級配層之上:** 應作好防水處理, 以防止地下水位上升影響甚至破壞環氧樹脂面層的施作。

### Concrete floor slab or AC layer:

surface require high level of evenness, but perfect levelness not required thus best to have slightly rough Surface finishing.

its normally requires 3-4 weeks to have the concrete floor slab to reach its optimum condition for application.

To be sure that the AC layer was hardly compressed with no hollow portion and allowed for 2-4 weeks to reach its optimum condition for application.

## Poxy Flooring



環氧樹脂無縫地臺漆

### 混凝土或 AC 面層:

其表面須力求平整, 但無須粉光, 且表面必須有微粗糙之素面。

混凝土層之養護時間須達到養護期 3-4 星期。

AC 層面必須要求確實壓實, 不得有空殼情形產生, 表面須完全達到養護, 養護時間需求為 2 - 4 星期。

## 環氧樹脂面層施工要求

### Requirements for epoxy flooring application:

To clean and clear the sub-floor slab and make sure that its foundation works upon to the required standards. Prior to the start of epoxy flooring application, the applied area must have less than 8% water content or to be approved by the on-site engineer. According to on-site situation to tailor-design the elastic joint.

施工前素地的整理、清潔, 并確定基礎工程是否達到施作要求, 測試欲施作素地其含水率須在 8% 以下之要求, 或經材料原廠駐地工程師核可後, 方得進行環氧樹脂工程鋪設。

依據現場素地狀況伸縮縫, 以達到完全物理特性之標準。

## 產品應用方面

食品、化學、電子、醫藥、商場、室內外運動場等之生產廠房地面及空間; 特別要求無縫、不收縮、耐磨、耐刮、耐衝擊、耐溫、耐鹼、防水、防油、防塵、防磨蝕之地臺; 金屬、水泥、木材等表面材料。

## 產品測試標準

刷塗性	硬度	耐水性 (24h)
刷塗後無痕, 對底材無影響	≥2H	不起泡, 不脫落
塗膜顏色及外觀力	附著	耐磨性(g)
漆膜平整、光滑	≤ 0%	≤ 0.039
細度	遮蓋	耐洗刷性(次)
≤35微米	≤45 (g/m <sup>2</sup> )	> 10000

面漆  
底漆  
基礎層



油掃

滾筒

噴塗